



Industrial 4G/LTE Cellular Router Series

« focus differently »

www.xentino.com

Industrial 4G/LTE Cellular Router Series



Secure and Reliable Connectivity for Internet of Things (IoT)

Wide Range of Mission-Critical Cellular
Communication Products













EN 61000-6-2
EN 61000-6-4



EN50121-4



HALT Approval

XENTINO Model Name	MR400	MR401	MR400-G	MR401-G	MR401-TPG	MR402-LG
Industrial 4G LTE Cellular Router (IP40/IP65/IP68) 						
Cellular Technology						
LTE Interface (2G, 3G, 4G)	GSM/WCDMA/LTE	GSM/WCDMA/LTE	GSM/WCDMA/LTE	GSM/WCDMA/LTE	GSM/WCDMA/LTE	GSM/WCDMA/LTE
LTE Band/Frequency	FDD LTE: B1/B3/B5/B7/B8/B20 TDD LTE: B38/B40/B41 WCDMA: B1/B5/B8 GSM: 900/1800 MHz LTE Cat4	FDD LTE: B1/B3/B5/B7/B8/B20 TDD LTE: B38/B40/B41 WCDMA: B1/B5/B8 GSM: 900/1800 MHz LTE Cat4	FDD LTE: B1/B3/B5/B7/B8/B20 TDD LTE: B38/B40/B41 WCDMA: B1/B5/B8 GSM: 900/1800 MHz LTE Cat4	FDD LTE: B1/B3/B5/B7/B8/B20 TDD LTE: B38/B40/B41 WCDMA: B1/B5/B8 GSM: 900/1800 MHz LTE Cat4	FDD LTE: B1/B3/B5/B7/B8/B20 TDD LTE: B38/B40/B41 WCDMA: B1/B5/B8 GSM: 900/1800 MHz LTE Cat4	FDD LTE: B1/B3/B5/B7/B8/B20 TDD LTE: B38/B40/B41 WCDMA: B1/B5/B8 GSM: 900/1800 MHz LTE Cat4
Antenna Connector	2 x SMA (MAIN + AUX)	2 x SMA (MAIN + AUX)	3 x SMA (MAIN + AUX + GPS)	3 x SMA (MAIN + AUX + GPS)	3 x SMA (MAIN + AUX + GPS)	3 x SMA (MAIN + AUX + GPS)
Communication Interface						
Ethernet	1 x 10/100 Mbps LAN 1 x 10/100 Mbps WAN	3 x 10/100 Mbps LANs 1 x 10/100 Mbps WAN	1 x 10/100 Mbps LAN 1 x 10/100 Mbps WAN	3 x 10/100 Mbps LANs 1 x 10/100 Mbps WAN	3 x 10/100 Mbps LANs 1 x 10/100 Mbps WAN	4 x 10/100 Mbps LANs
PoE	N/A	N/A	N/A	N/A	1 x IEEE 802.3at/af PoE P.D.	N/A
SIM Card	2	2	2	2	2	2
Serial	1 x RS485 (D+/D-) 1 x RS232 (TXD/RXD)	1 x RS485 (D+/D-) 1 x RS232 (TXD/RXD)	1 x RS485 (D+/D-) 1 x RS232 (TXD/RXD)	1 x RS485 (D+/D-) 1 x RS232 (TXD/RXD)	1 x RS485 (D+/D-) 1 x RS232 (TXD/RXD)	N/A
Console Port	RS232	RS232	RS232	RS232	RS232	RS232
I/O	2 x DI, 1 x DO (Alarm +/-)	2 x DI, 1 x DO (Alarm +/-)	2 x DI, 1 x DO (Alarm +/-)	2 x DI, 1 x DO (Alarm +/-)	2 x DI, 1 x DO (Alarm +/-)	N/A
GPS	N/A	N/A	1	1	1	1
Temperature & Power						
Operating Temperature	-20 to +70 °C	-20 to +70 °C	-20 to +70 °C	-20 to +70 °C	-40 to +75 °C	-20 to +70 °C
Input Voltage	10~32 VDC	10~32 VDC	10~32 VDC	10~32 VDC	10~32 VDC	10~32 VDC
Power Consumption	< 7W	< 7W	< 7W	< 7W	< 7W	< 7W
Mechanical Construction						
Dimensions (W x H x D)	60 x 110 x 106 mm	60 x 110 x 106 mm	60 x 110 x 106 mm	60 x 110 x 106 mm	60 x 110 x 106 mm	60 x 110 x 106 mm
Weight	451 g (0.9943 lb)	452 g (0.9965 lb)	451 g (0.9943 lb)	452 g (0.9965 lb)	452 g (0.9965 lb)	391 g (0.8620 lb)
Installation	DIN Rail (Default) Wall Mount (Optional)	DIN Rail (Default) Wall Mount (Optional)	DIN Rail (Default) Wall Mount (Optional)	DIN Rail (Default) Wall Mount (Optional)	DIN Rail (Default) Wall Mount (Optional)	DIN Rail (Default) Wall Mount (Optional)
Enclosure	IP40 Aluminum Case	IP40 Aluminum Case	IP40 Aluminum Case	IP40 Aluminum Case	IP40 Aluminum Case	IP40 Aluminum Case
Software Specifications	(Common specs for all models)					
Network Protocols	IPv4, IPv6, IPv4/IPv6 dual stack, DHCP server and client, PPPoE, Static IP, SNTP, GPS sync time, DNS Proxy, *Modbus, VRRP, OSPF, Message Queue Telemetry Transport (MQTT Broker), BGP					
Routing/Firewall	NAT, Virtual Server, DMZ, MAC Filter, URL Filter, IP Filter, VLAN, Static Routing and RIP-1/2					
VPN Security	OpenVPN, IPsec (3DES, AES128, AES196, AES256, MD5, SHA-1, SHA256), GRE, PPTP, L2TP					
Wireless Connectivity	Two SIM for failover/ roaming over/ back up, Two SIM data usage control, Seamless multi WAN connections switch					
Alarm	*DI, *DO, SMS, VPN/WAN Disconnect, SNMP Trap, E-mail (*The MR402-LG doesn't support Modbus and DI/DO without serial ports)					
Others	DDNS, QoS, Virtual COM, UPnP					
Management Software (All Models)	Web GUI for remote and local management, CLI, Dual Image firmware upgrade by Web GUI, SysLOG Monitor, SNMP, TR069 Remote Management via SSH v2, HTTPS, Local Management via Telnet, SSH v2, HTTP/HTTPS					
					   	

MR400

- LTE Cat4, FDD/TDD LTE, 3G/WCDMA, 2G/GSM
- 1 x ETH LAN, 1 x ETH WAN
- 2 x RS232, 1 x RS485, I/O - 2 x DI + 1 x DO
- Dual SIM Slot (Support FailOver)
- Operating Temp. -20 °C ~ +70 °C
- Power Supply 10 to 32 VDC
- Industrial-Grade Hardware,
- SW IIoT Applications, MQTT/ModBus Support
- IPv4/IPv6 Dual Stack, VPN Tunnels
- SPI Firewall, TR069, Diagnostics
- IP40 Protection, DIN Rail Mounting



MR400-G

- LTE Cat4, FDD/TDD LTE, 3G/WCDMA, 2G/GSM
- 1 x ETH LAN, 1 x ETH WAN
- **1 x GPS Antenna Int.**
- 2 x RS232, 1 x RS485, I/O - 2 x DI + 1 x DO
- Dual SIM Slot (Support FailOver)
- Operating Temp. -20 °C ~ +70 °C
- Power Supply 10 to 32 VDC
- Industrial-Grade Hardware,
- SW IIoT Applications, MQTT/ModBus Support
- IPv4/IPv6 Dual Stack, VPN Tunnels
- SPI Firewall, TR069, Diagnostics
- IP40 Protection, DIN Rail Mounting



MR401

- LTE Cat4, FDD/TDD LTE, 3G/WCDMA, 2G/GSM
- 3 x ETH LAN, 1 x ETH WAN
- 2 x RS232, 1 x RS485, I/O - 2 x DI + 1 x DO
- Dual SIM Slot (Support FailOver)
- Operating Temp. -20 °C ~ +70 °C
- Power Supply 10 to 32 VDC
- Industrial-Grade Hardware,
- SW IIoT Applications, MQTT/ModBus Support
- IPv4/IPv6 Dual Stack, VPN Tunnels
- SPI Firewall, TR069, Diagnostics
- IP40 Protection, DIN Rail Mounting

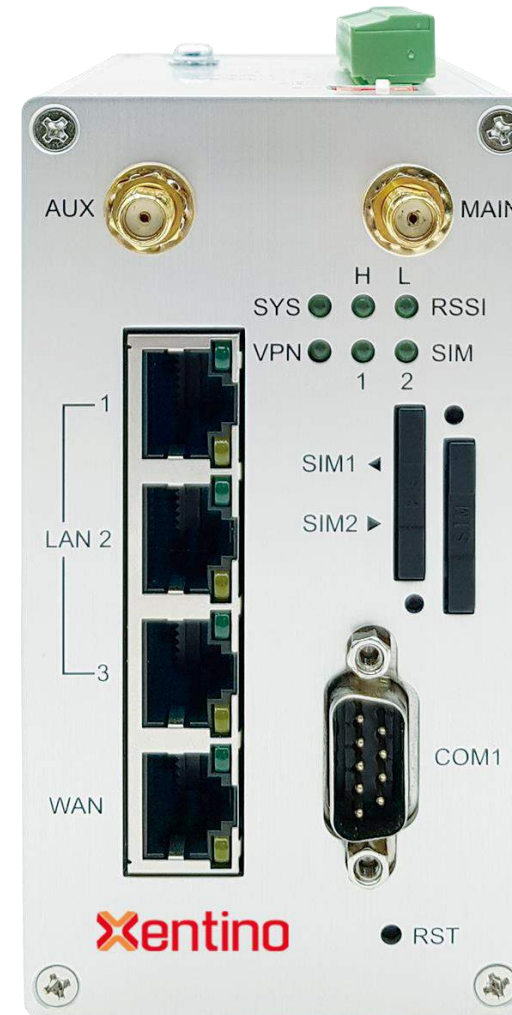

MR401-G

- LTE Cat4, FDD/TDD LTE, 3G/WCDMA, 2G/GSM
- 3 x ETH LAN, 1 x ETH WAN
- **1 x GPS Antenna Int.**
- 2 x RS232, 1 x RS485, I/O - 2 x DI + 1 x DO
- Dual SIM Slot (Support FailOver)
- Operating Temp. -20 °C ~ +70 °C
- Power Supply 10 to 32 VDC
- Industrial-Grade Hardware,
- SW IIoT Applications, MQTT/ModBus Support
- IPv4/IPv6 Dual Stack, VPN Tunnels
- SPI Firewall, TR069, Diagnostics
- IP40 Protection, DIN Rail Mounting

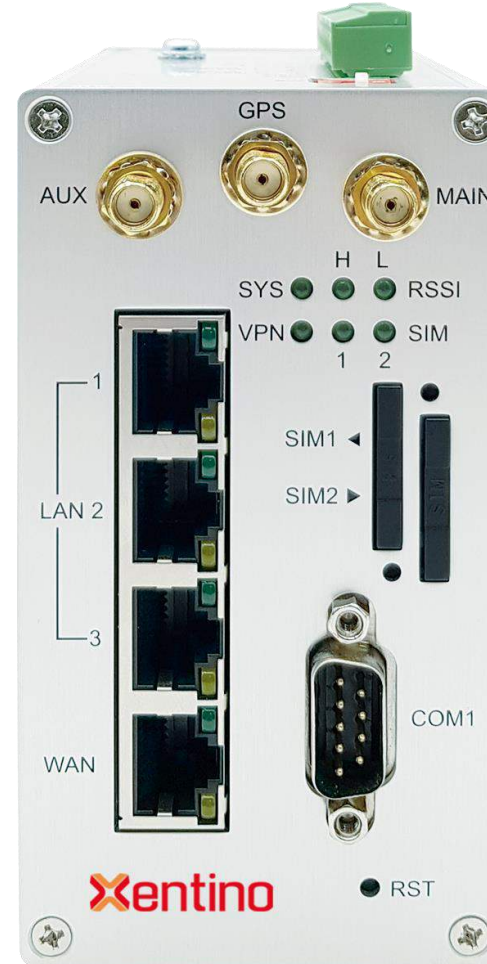

MR401-TPG

- LTE Cat4, FDD/TDD LTE, 3G/WCDMA, 2G/GSM
- 3 x ETH LAN
- **1 x ETH WAN with IEEE 802.3at/af PoE PD**
- **1 x GPS Antenna Int.**
- 2 x RS232, 1 x RS485, I/O - 2 x DI + 1 x DO
- Dual SIM Slot (Support FailOver)
- **Operating Temp. -40 °C ~ +75 °C**
- Power Supply 10 to 32 VDC
- Industrial-Grade Hardware,
- SW IIoT Applications, MQTT/ModBus Support
- IPv4/IPv6 Dual Stack, VPN Tunnels
- SPI Firewall, TR069, Diagnostics
- IP40 Protection, DIN Rail Mounting

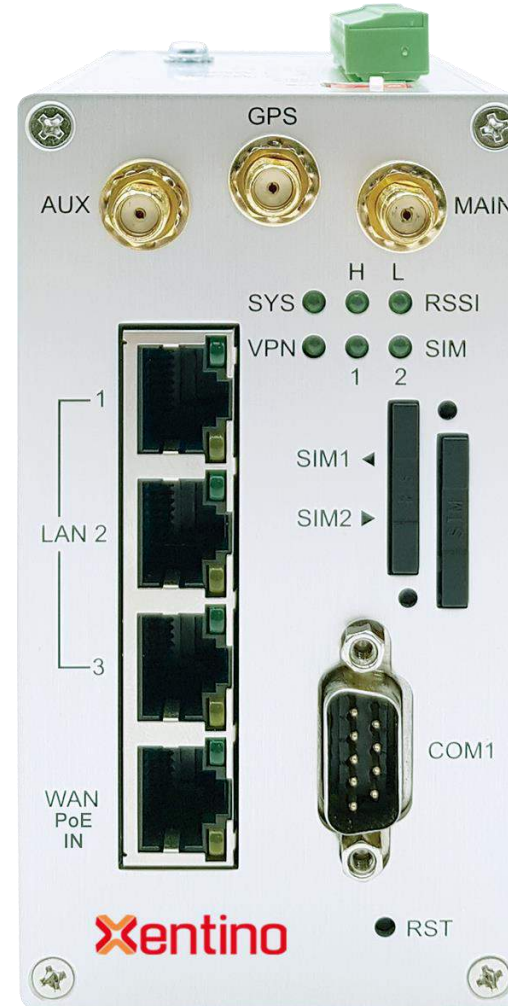

MR402-LG

- LTE Cat4, FDD/TDD LTE, 3G/WCDMA, 2G/GSM
- 4 x ETH LAN
- **1 x GPS Antenna Int.**
- Dual SIM Slot (Support FailOver)
- Operating Temp. -20 °C ~ +70 °C
- Power Supply 10 to 32 VDC
- Industrial-Grade Hardware,
- SW IIoT Applications, MQTT/BGP Support
- IPv4/IPv6 Dual Stack, VPN Tunnels
- SPI Firewall, TR069, Diagnostics
- IP40 Protection, DIN Rail Mounting

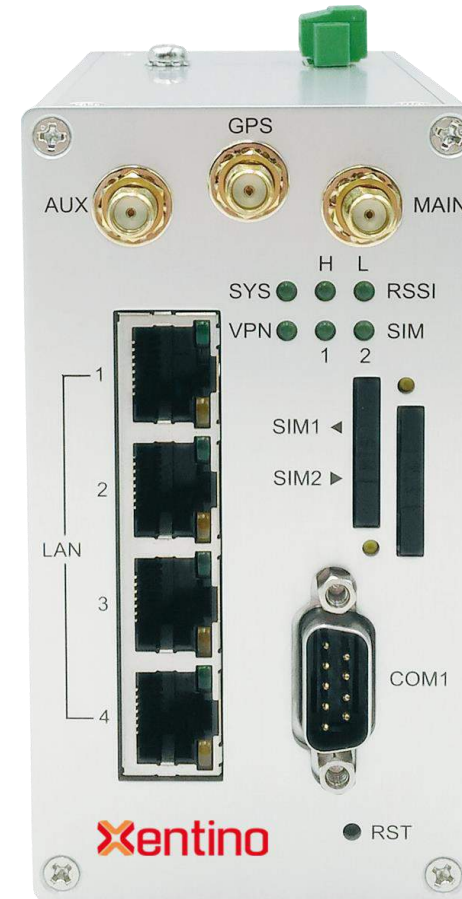

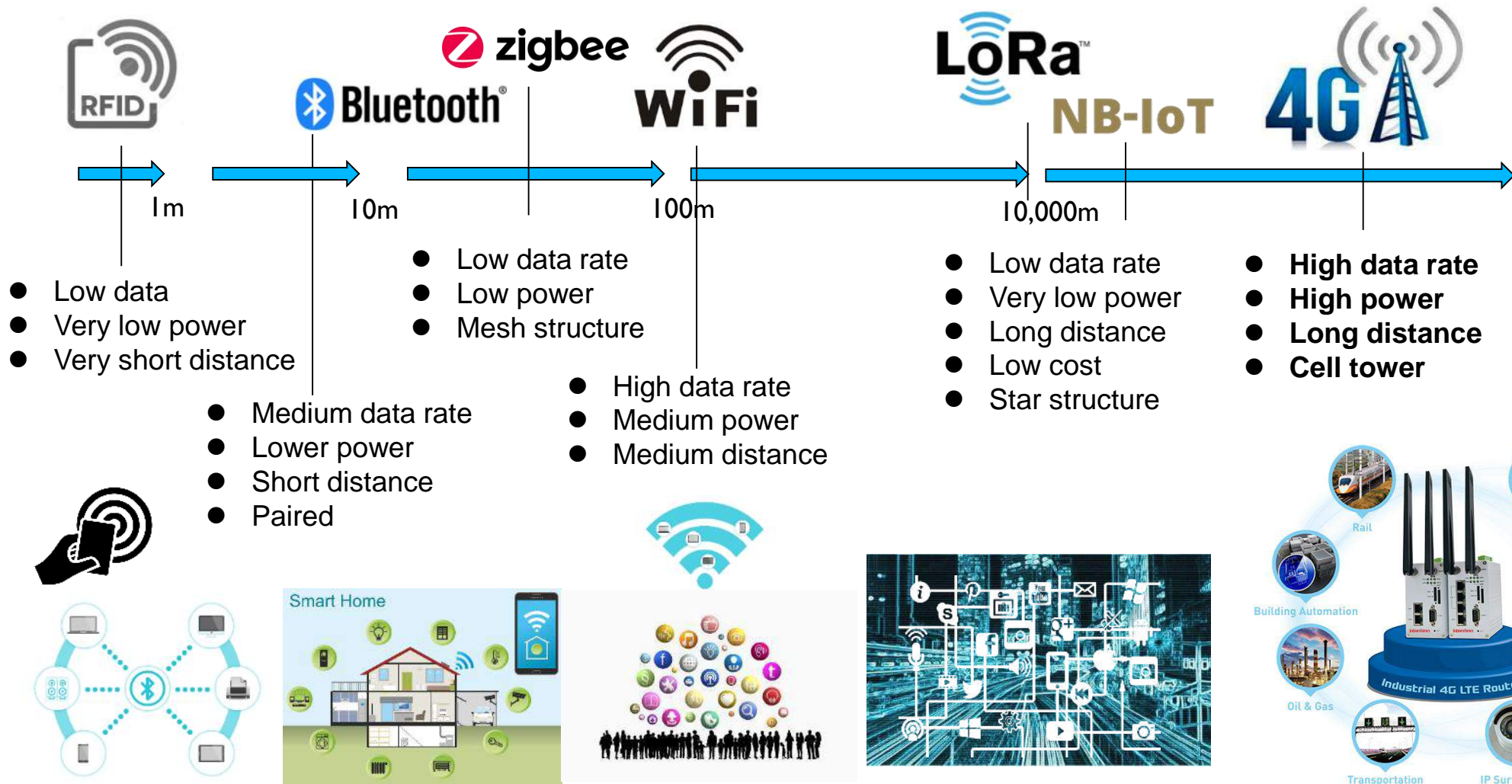

* Above logo belongs to each industry copyright.

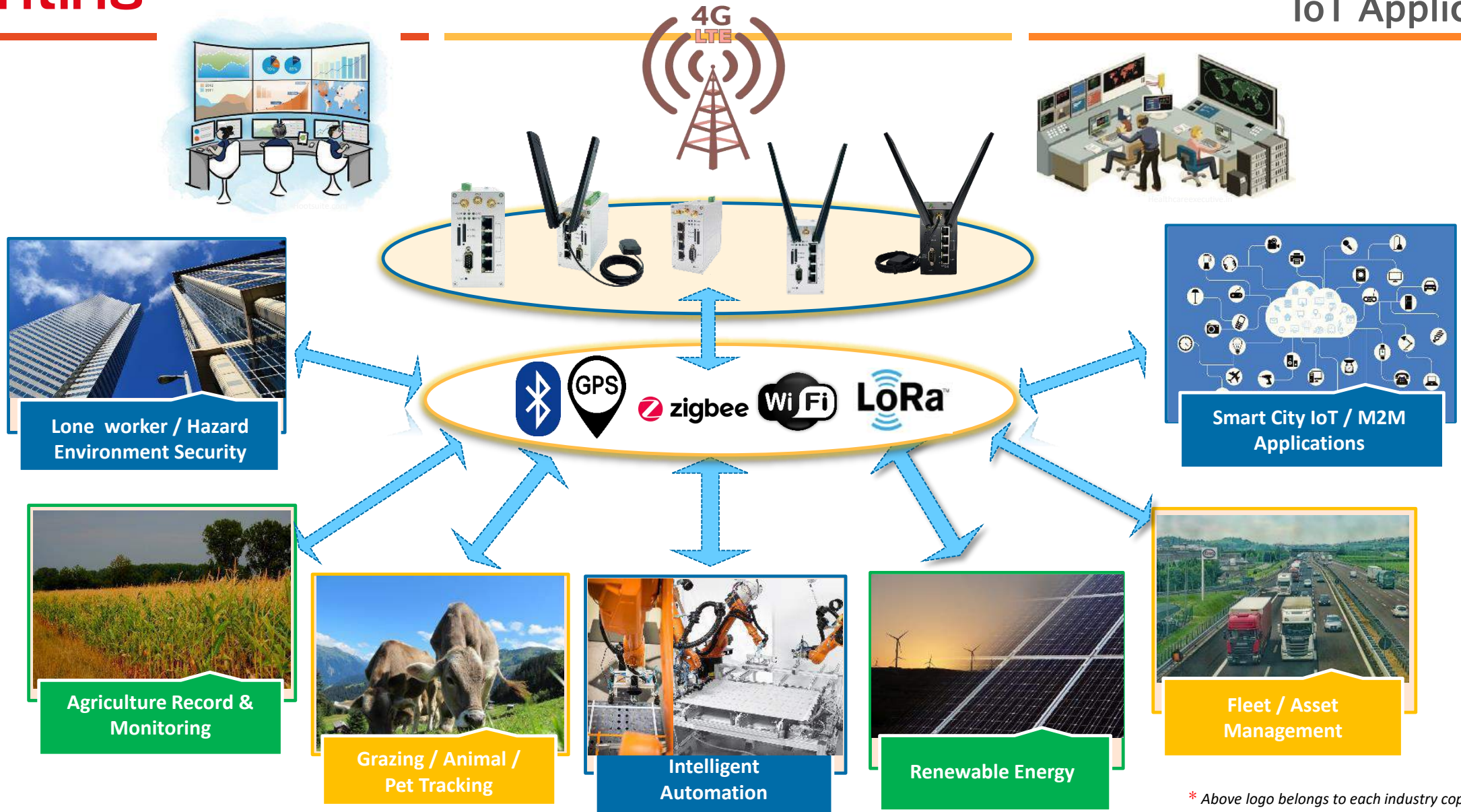

* Above logo belongs to each industry copyright.





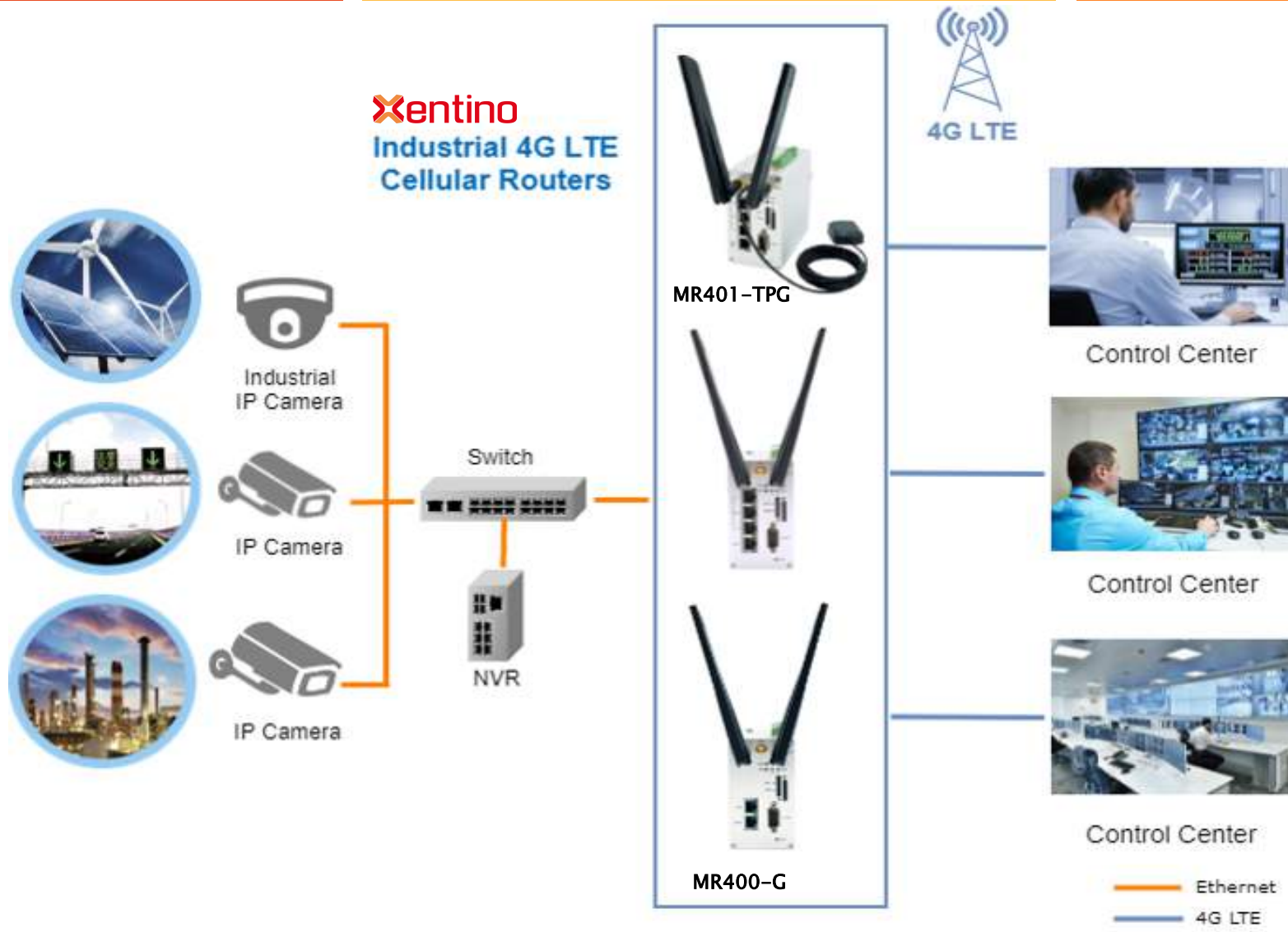

* Above logo belongs to each industry copyright.

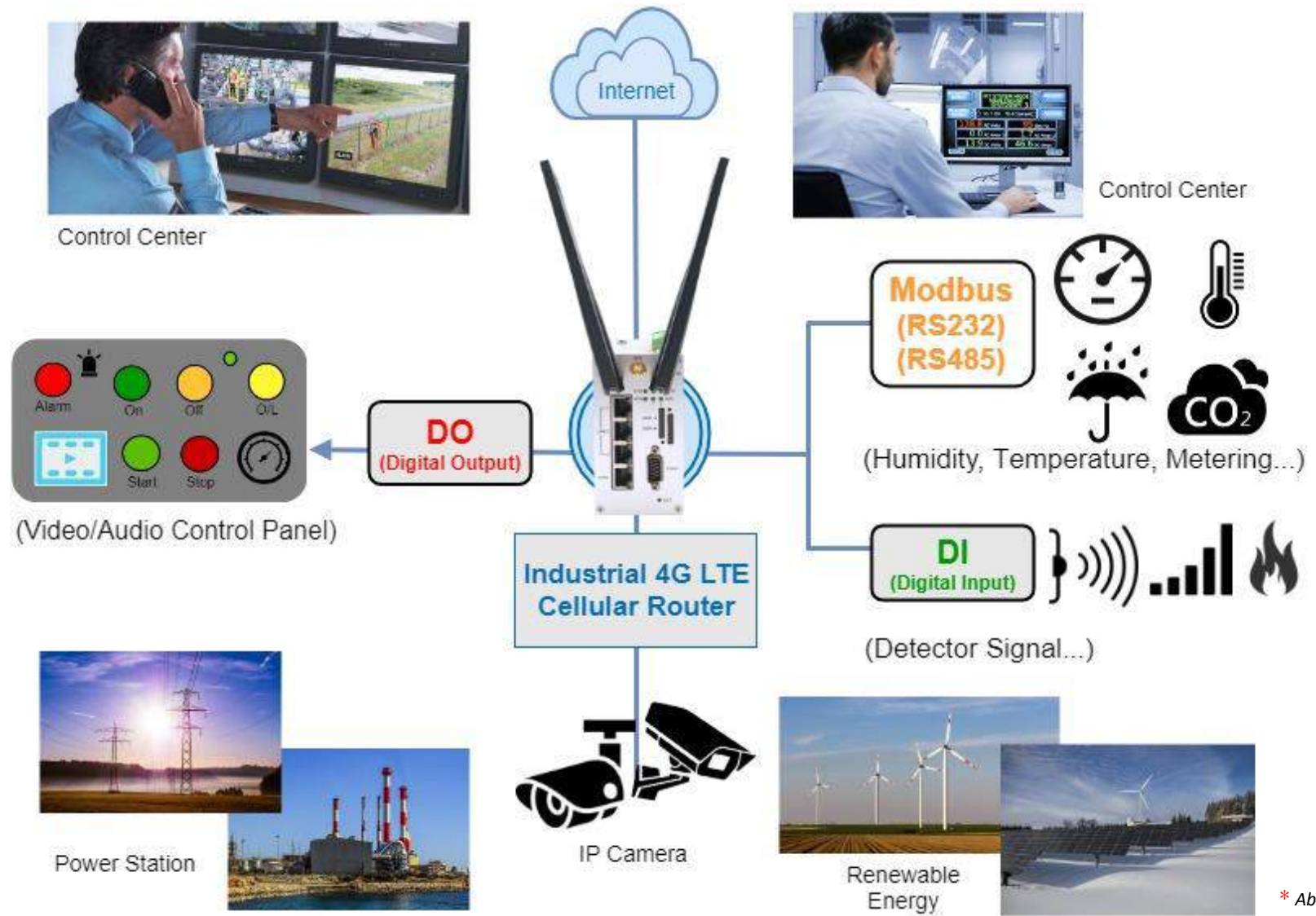

* Above logo belongs to each industry copyright.

- Provide ideal solutions for reliable high-bandwidth data transmission between the numerous traffic points and the traffic control center.
- Deploy highway or roadside intelligent traffic control electronic toll collection systems, intersection monitoring systems, and CMS boards.

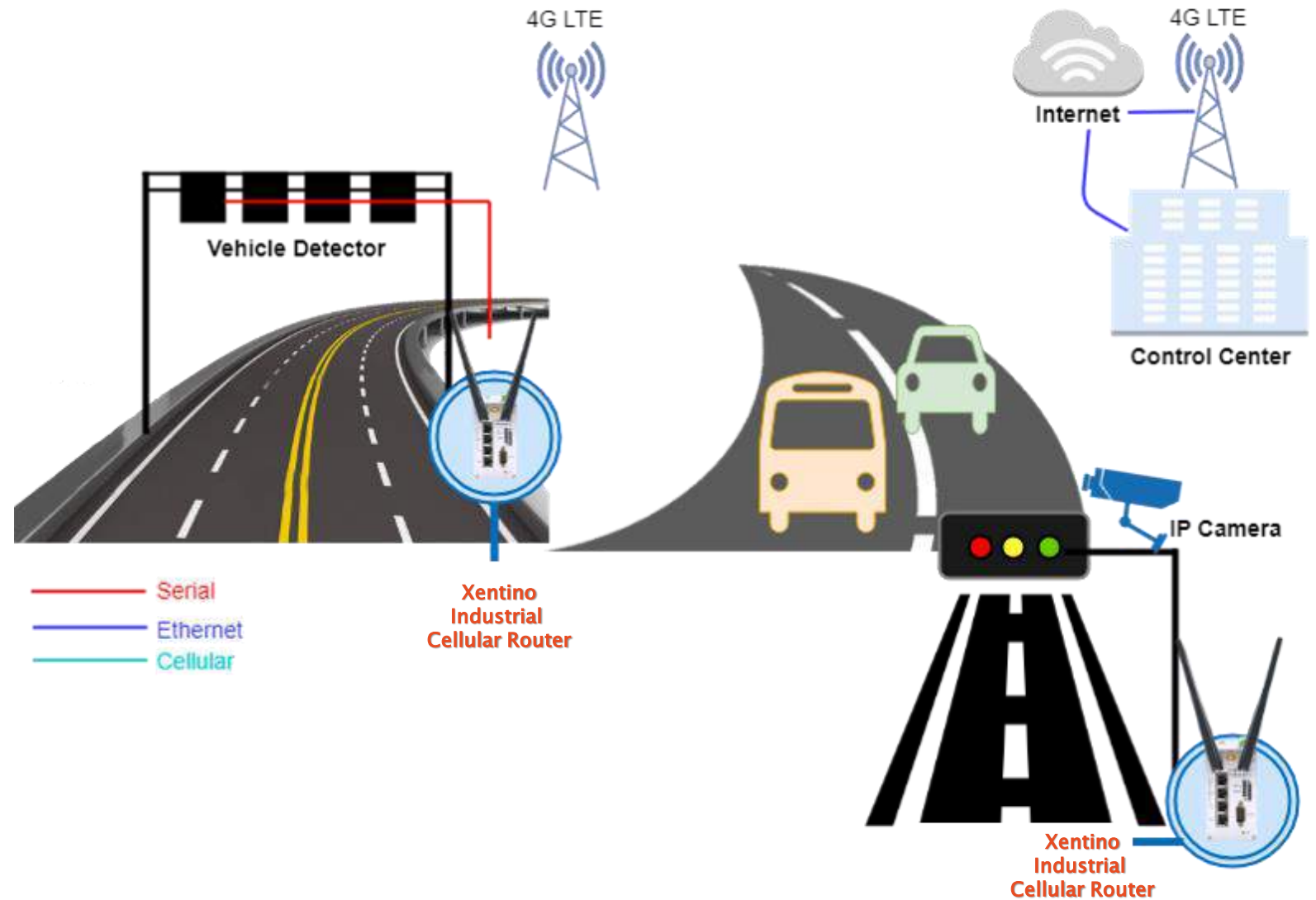

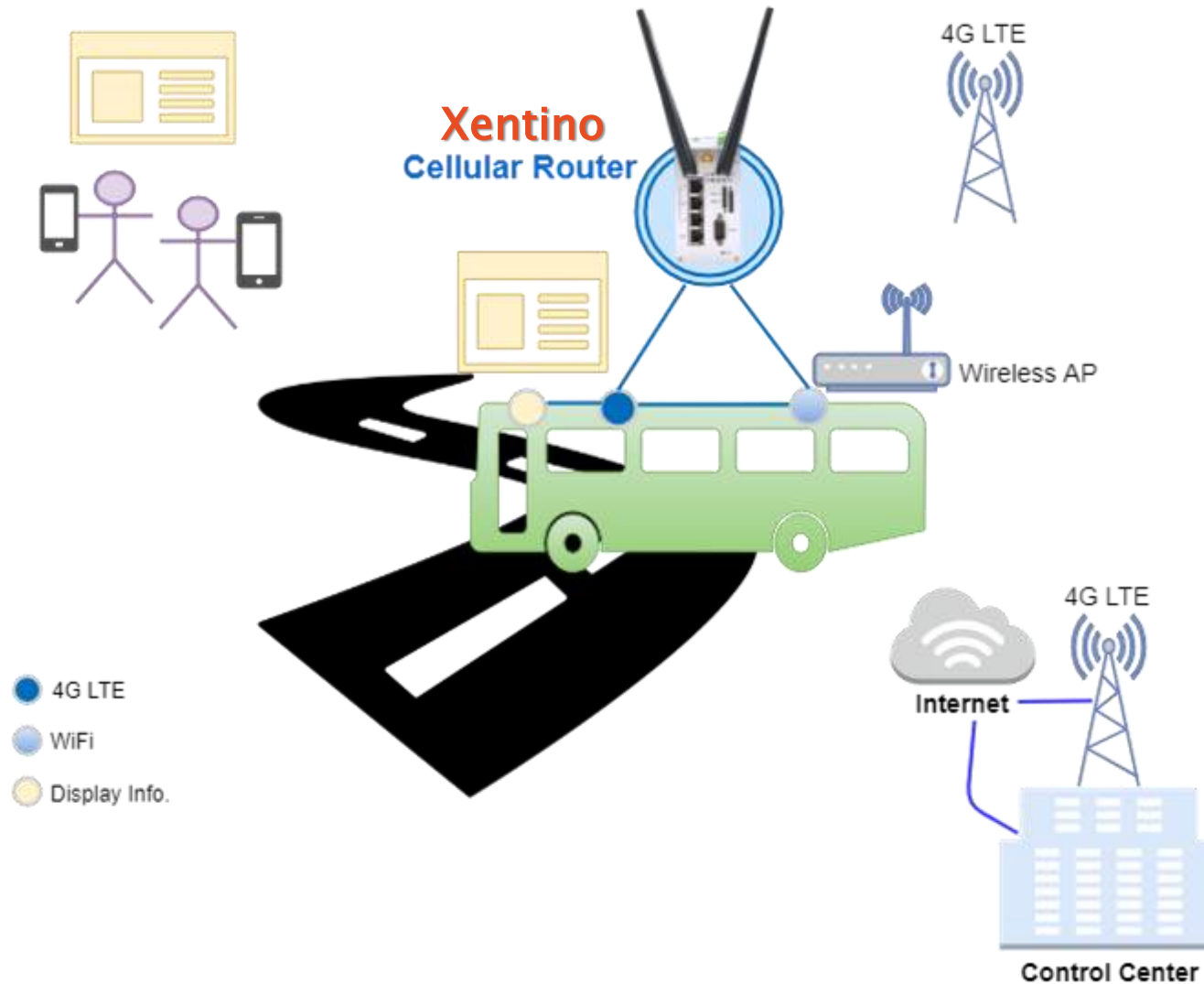

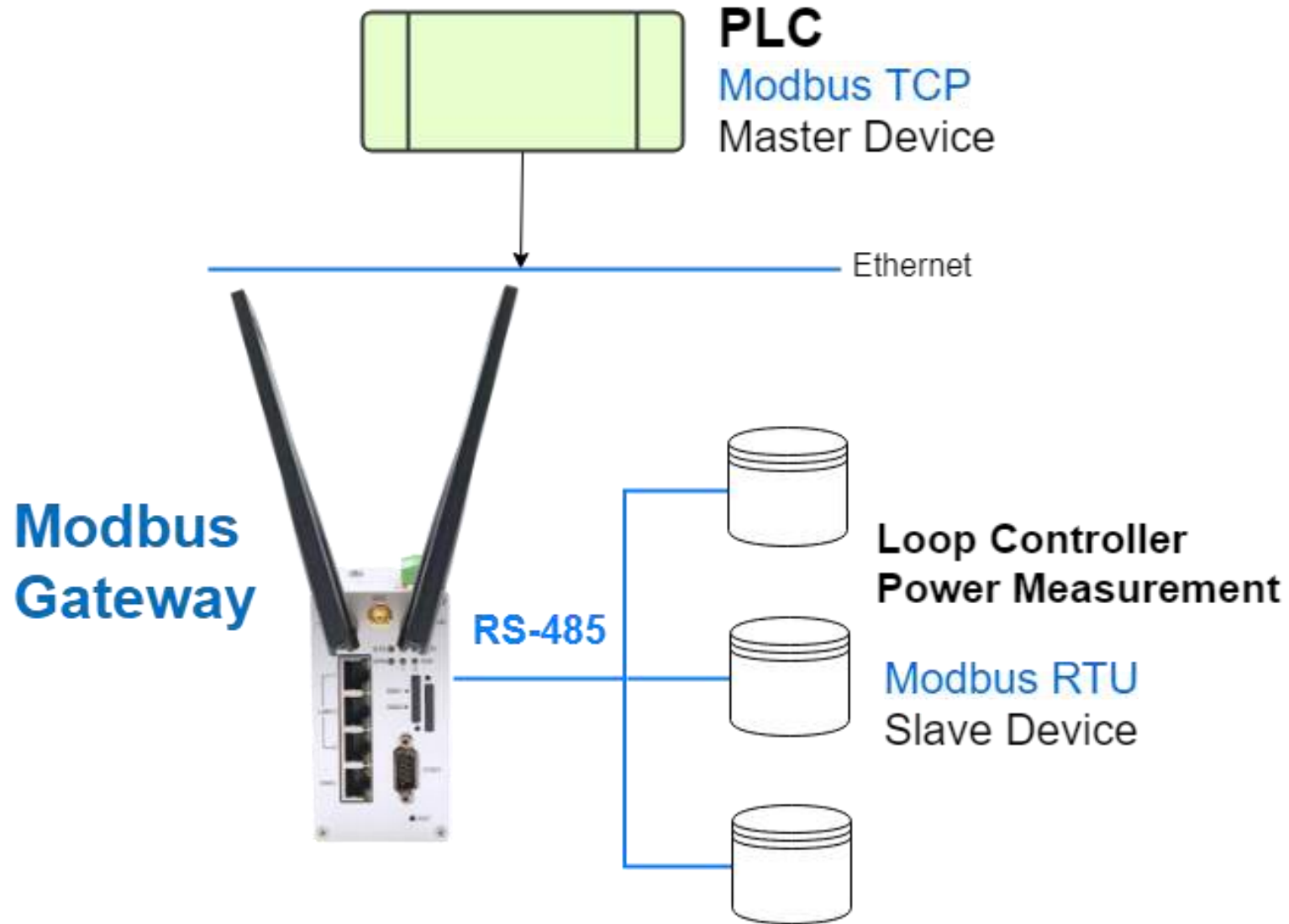

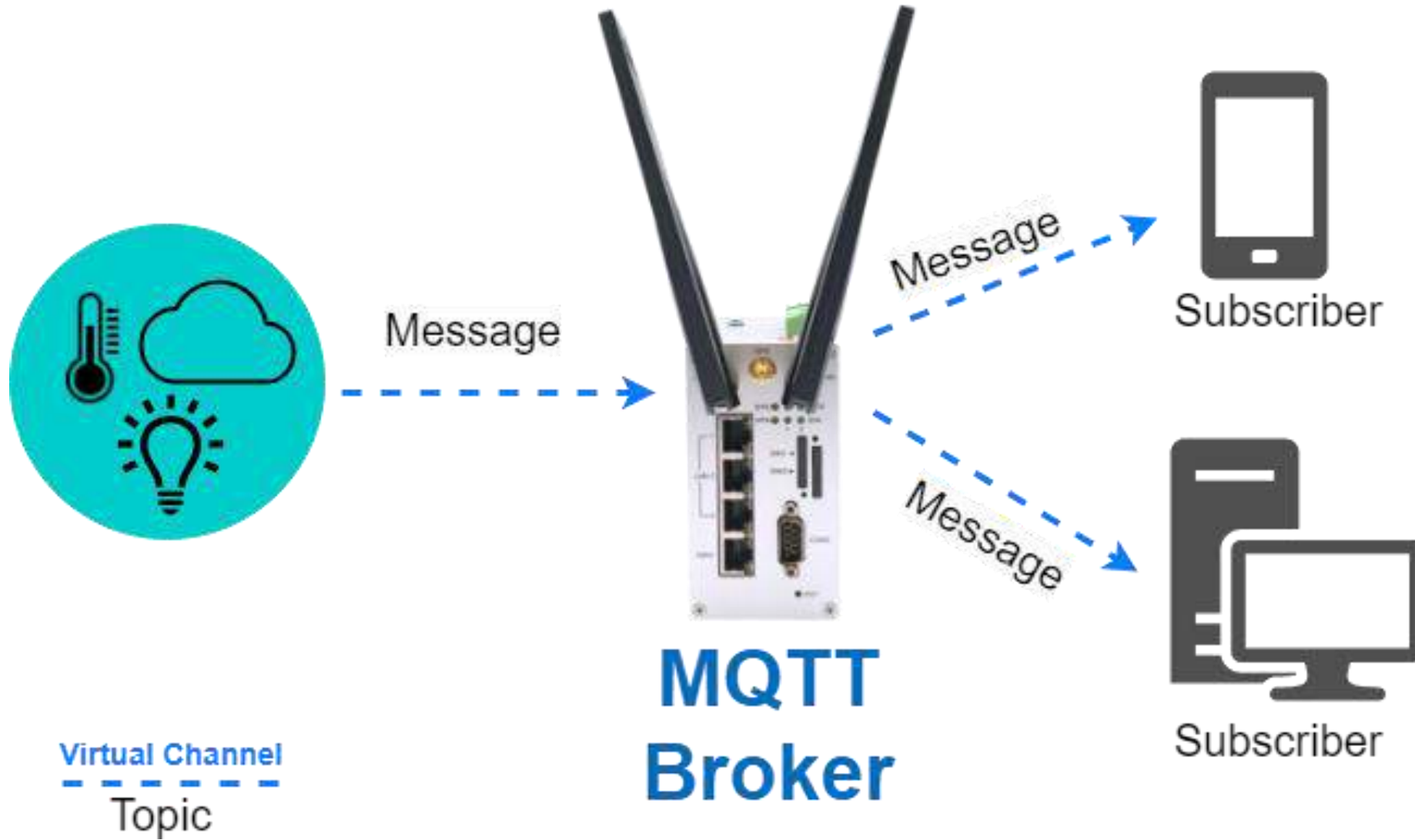

XENTINO TECHNOLOGIES CORP.

5F. No.89 Aly. 3 Ln. 182 Sec. 2 Wenhua Rd. Banqiao Dist. New Taipei City 22044
Taiwan (R.O.C)

Tel : +886-282581593

Fax : + 886-282581592

www.xentino.com

info@xentino.com

Xentino
www.xentino.com

Thank you!



